

### Typical Features

- ◆ Wide input voltage range 3.1LKL:1
- ◆ High efficiency up to 89%
- ◆ Low no-load power consumption
- ◆ Operating Temperature: -40°C to +105°C
- ◆ High isolation voltage, input-output 3000VAC, input-case 2000VAC
- ◆ Protection: Input under voltage, output over voltage, short circuit, over current, over temp
- ◆ Standard 1/2 brick



Conform to CE standard

**ZBA200-220SXX** ZBA200-220SXX is a high-performance AC module power supply, rated input voltage 220VAC, output maximum power is 200W, no minimum load, wide input 85-264VDC, regulated single output, high isolation insulation voltage, allowing operating temperature up to 105°C, with input under-voltage protection, output over-current, over-voltage, over-temperature, short-circuit protection, remote control and remote compensation, output voltage regulation and other functions.

### Typical Product List

Part no	Input voltage range (VAC)	Output Voltage (VDC)	Output Voltage Range (VDC)	Output Current (A)	Full load efficiency(%) Min/Typ.	Ripple & Noise (mV)	Output Power
ZBA150-220S12	85-264	12	9-16	12.5	84	120	150
ZBA200-220S24		24	22-32	8.3	85	240	200
ZBA200-220S48		48	32-54	4.2	86	480	200

Note: When the input is 176-85Vac, the output is linearly derated; when the input is 85Vac, the maximum output power is 100W.

### Input Specification

Item	Operating conditions	Min.	Typ.	Max.	Unit
Start up voltage		--	--	85	VAC
Input under voltage protection		70	75	80	
Input over voltage protection		290	--	310	
Input surge voltage (1sec. max.)	Inputs above this range may cause permanent damage	-0.7	--	315	
Input maximum inrush current	Input wire series 5.6R, 20mm diameter thermal, 220Vac input	--	--	55	A
Input voltage frequency		47	--	63	Hz
Start up time		--	--	3	S
Standby power consumption	220Vac input	--	--	3	W
PF value	220Vac input, full load output	95	--	--	%

### Output Specification

Item	Working conditions	Min.	Typ.	Max.	Unit
Output Voltage Accuracy	Nominal input voltage, 0%-100% load	--	±0.5	±1	%
Line Regulation	Full load, input voltage from low to high	--	±0.2	±0.5	
Load Regulation	Nominal input voltage, 10%-100% load	--	±0.2	±0.5	
Output Voltage Accuracy	Full input voltage, 0%-100% load	--	±1.0	±2.0	

Transient recovery time	25% load step change (step rate 1A/50uS)	--	200	250	uS
Transient Response Deviation		-5	--	5	%
Temperature Drift Coefficient	Full load	-0.02	--	+0.02	%/°C
Ripple & Noise	20M bandwidth, external capacitor above 220uF	--	--	1	%Vo
Output voltage adjustment (TRIM)	ZBA150-220S12	9	12	16	Vdc
	ZBA150-220S24	16	24	32	
	ZBA150-220S48	32	48	54	
Output voltage remote compensation (Sense)		--	--	105	%
Over temp protection	Maximum temperature of product metal substrate surface	105	115	125	°C
Output over voltage protection		125	--	140	%
Output over current protection		105	--	150	%Io
Output short circuit protection		Hiccup, continuous, self-recovery			

**General Specification**

Item	Operating conditions		Min.	Typ.	Max.	Unit
Isolation Voltage	I/P-O/P	Test 1min, leakage current < 3mA	3000	--	--	VAC
	I/P-Case	Test 1min, leakage current < 3mA	2100	--	--	VAC
	O/P-Case	Test 1min, leakage current < 3mA	500	--	--	VDC
Insulation resistance	I/P-O/P	Insulation voltage 500VDC	100	--	--	MΩ
Switching frequency			--	250	--	KHz
MTBF			150	--	--	K hours

**Environmental characteristics**

Item	Operating conditions		Min.	Typ.	Max.	Unit
Operating Temperature	See temperature derating curve		-40	--	+105	°C
Storage Humidity	No condensing		5	--	95	%RH
Storage Temperature			-40	--	+125	°C
Soldering resistance of pins	The solder joint is 1.5mm away from the shell, and the soldering time < 1.5S		--	--	+350	
Cooling requirements			EN60068-2-1			
Dry and heat requirements			EN60068-2-2			
Moisture and heat requirements			EN60068-2-30			
Shock and vibration			IEC/EN 61373 Body 1 B Class			

**EMC Characteristics(EN50155)**

EMI	CE	EN50121-3-2	150kHz-500kHz 79dBuV		
		EN55016-2-1	500kHz-30MHz 73dBuV		
	RE	EN50121-3-2	30MHz-230MHz 40dBuV/m at 10m		
		EN55016-2-1	230MHz-1GHz 47dBuV/m at 10m		
EMS	ESD	EN50121-3-2	Contact ±6KV/Air ±8KV		perf. Criteria A
	RS	EN50121-3-2	10V/m		perf. Criteria A
	EFT	EN50121-3-2	±2kV 5/50ns 5kHz		perf. Criteria A
	Surge	EN50121-3-2	line to line ± 1KV (42Ω, 0.5μF)		perf. Criteria A
	CE	EN50121-3-2	0.15MHz-80MHz 10 Vr.m.s		perf. Criteria A

**Physical Characteristics**

Case Materials	Metal bottom shell + black flame retardant material shell (UL94 V-0)
Cooling method H	Conduction cooling or forced air cooling
Product Weight	Standard 130g, with heatsink 200g

**Dimension and Pin-Out**

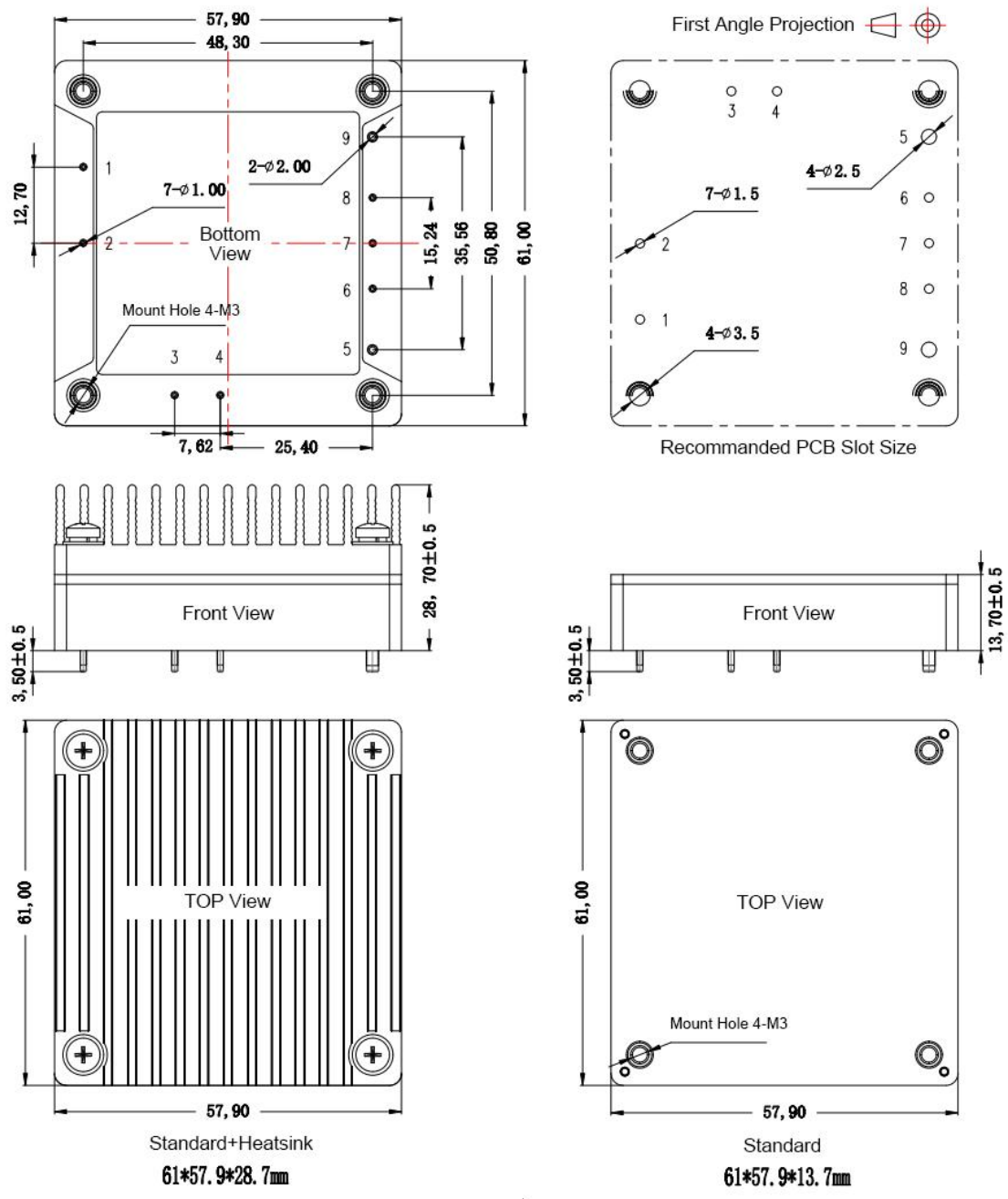

Note:  
 Unit: mm  
 Pin 1, 2, 3, 5, 6, 7 dia: 1.00  
 Pin 4, 8 dia: 2.00  
 General Tolerance:  $\pm$ 0.10  
 Mounting Hole Tightening Torque: Max 0.4N\*m



	<b>1</b>	<b>2</b>	<b>3</b>	<b>4</b>	<b>5</b>	<b>6</b>	<b>7</b>	<b>8</b>	<b>9</b>
Pin-out	AC1	AC2	BC+	BC-	Vout+	+S	TRIM	-S	Vout-

**Product Characteristic Curve**

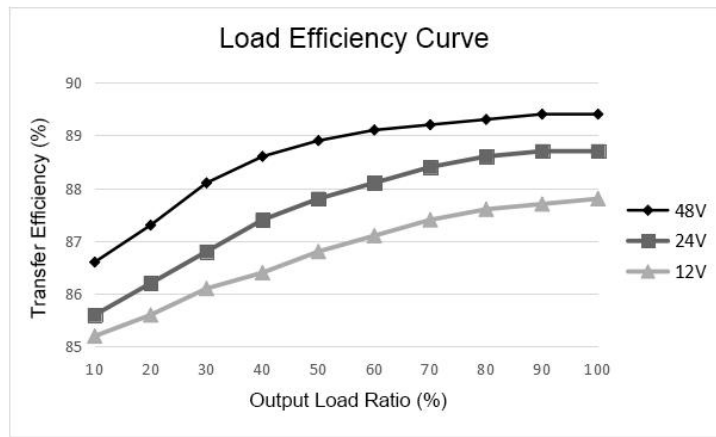
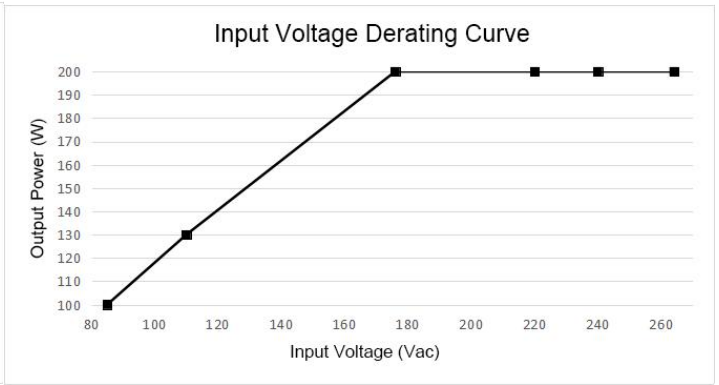
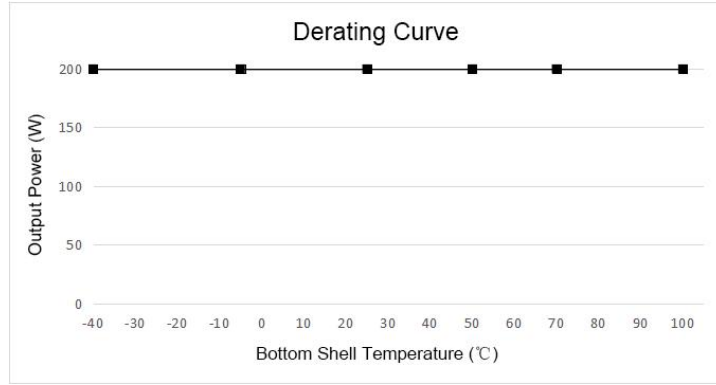

**Note:**  
 1. Both the temperature derating curve and the efficiency curve are tested with typical values;  
 2. The temperature derating curve is tested according to our laboratory test conditions. If the actual environmental conditions used by customers are inconsistent, it is necessary to ensure that the temperature of the aluminum casing of the product does not exceed 100 °C, and it can be used within any rated load range.

**Design Reference**

**1.Recommended application circuit**

If customer does not use the circuit recommended by our company, please be sure to connect an electrolytic capacitor of at least 100 μF in parallel at the input end to suppress the possible surge voltage at the input end.

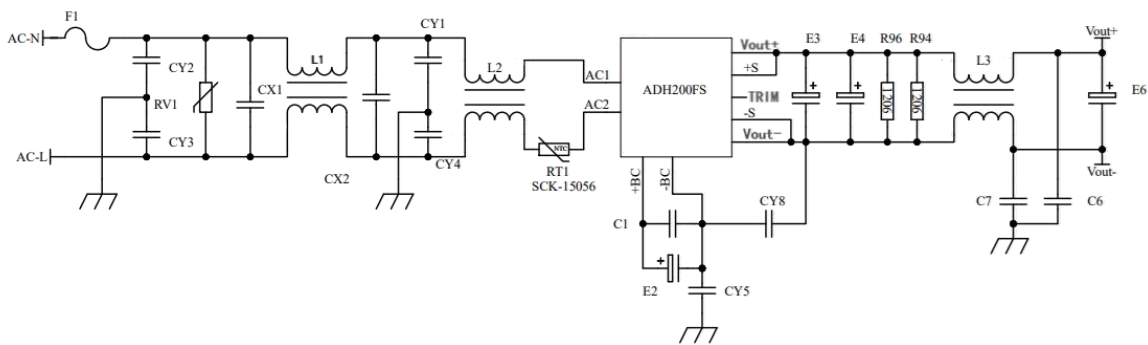

- Recommended parameters:
- F1 uses slow-blow insurance, 3.15A is recommended;
  - The overcurrent capability of L1 and L2 is greater than 2A, and the inductance is greater than 10mH; L3 uses 500uH, and the overcurrent capability must not be less than 120% of the rated output current;
  - CY1-CY5, use 102/250Vac, Y2 capacitor; CY8 uses 471/275Vac, Y1 capacitor; C6, C7 use 103/1KV ceramic capacitor;
  - CX1 and CX2 use X1 capacitor 474/275Vac; C1 uses film capacitor with good low temperature characteristics 105/630V (required below -25°C ambient temperature);
  - E2 uses capacitors above 450V/100UF; E3, E4, and E6 have capacities greater than 220uf, and the rated voltage must not be lower than the actual output voltage;
  - R96 and R94 can choose the dummy load according to the needs.

**2. Sense usage and precautions**

(1) Without far-end

compensation:

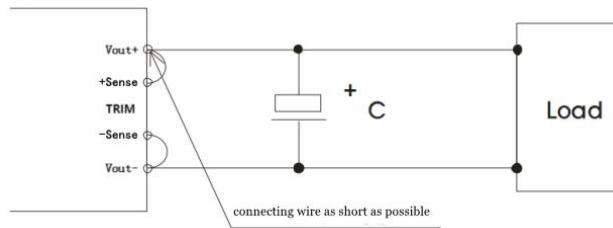

Precautions:

1. Do not use remote compensation, make sure Vout+ and Sense+, Vout- and Sense- are short-circuited;
2. The connection between Vout+ and Sense+, Vout- and Sense- should be as short as possible and close to the pins, otherwise the module may become unstable.

(2) Using remote

compensation

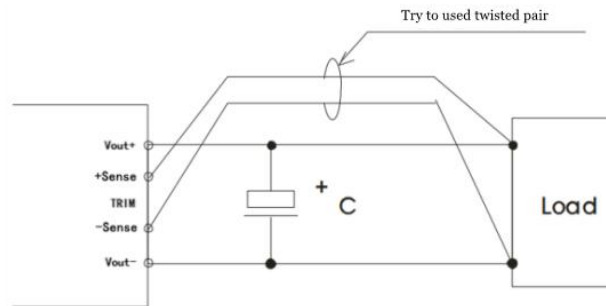

Precautions:

1. When the long-end compensation lead is used, the output voltage may be unstable;
2. If remote compensation is used, please use twisted pair or shielded wire, and keep the lead wire as short as possible;
3. Please use wide PCB leads or thick wires between the power module and the load, and keep the line voltage drop below 0.3V to ensure that the power output voltage remains within the specified range;
4. The impedance of the leads may cause the output voltage to oscillate or have larger ripples. Please verify it before use.

**3. Use of TRIM and calculation of TRIM resistance**

The relationship between output change voltage  $\Delta U$  and resistance is as follows:

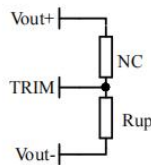

Voltage up regulation: add resistor  $R_{up}$  between Trim and output negative

$$R_{up} = 50 / \Delta U - 5.1 \text{ (K}\Omega\text{)}$$

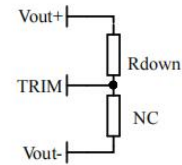

Voltage Down: Add resistor  $R_{down}$  between Trim and output positive

$$R_{down} = 20 * (V_o - 2.5 - \Delta U) / \Delta U - 5.1 \text{ (K}\Omega\text{)}$$

**4. This product does not support the use of direct parallel connection to increase the power. If you need to use it in parallel, please consult our technical staff.**

**Others**

- 1 The warranty period of this product is two years. During the normal damage, it will be repaired free of charge. Damages caused by errors in the use method or manufacturing technology, a paid service is provided.
- 2 Our company can provide product customization and matching filter modules. For details, please contact our technical staff directly.

**Guangzhou Aipu Electron Technology Co., Ltd**

Address: Building 4, HEDY Park, No.63, Punan Road, Huangpu Dist, Guangzhou, China.

Tel: 86-20-84206763 Fax: 86-20-84206762 HOTLINE: 400-889-8821

E-mail: sales@aipu-elec.com Website: <https://www.aipupower.com>