



Typical Features

- ◆ Wide input voltage range (4 : 1)
- ◆ Efficiency up to 91%
- ◆ Low no-load power consumption
- ◆ Operating temperature from -40°C to +105°C
- ◆ High isolation voltage 3000VAC (input-output) & 2100VAC (input-case)
- ◆ Input under voltage & over voltage protections, output over voltage, short circuit, over current and over temperature protections
- ◆ Standard full brick size

ZAD600-110S28A is a high-performance DC-DC modular converter with the rated input voltage 110VDC (full range from 43V to 160VDC), regulated single output 28V/600W without minimum load limit. It has the advantage of high isolation voltage, Max operating temperature up to 105°C, with input under-voltage & over voltage protections, output over-current, over-voltage, over-temperature and short circuit protections, input ON/OFF control, output voltage distal end compensation and output voltage Trim, etc. It is compliant with the railway standard EN50155 and widely used in the railway systems related equipment.

Typical Product List							
Part No.	Input voltage range (VDC)	Output power (W)	Output voltage (VDC)	Output current (A)	Ripple & Noise (mVp-p)	Full load efficiency (%) Min/Typ.	Remarks
ZAD600-110S28AC	43-160	600	28	21.4	280	89/91	Standard Positive logic
ZAD600-110S28AN							Standard Negative logic
ZAD600-110S28AC-H							Heatsink Positive logic
ZAD600-110S28AN-H							Heatsink Negative logic

Note: The output power could be derated linearly at the input range of 43-66V. The maximum output power is 400W at input 43V.

Input Specifications							
Item	Operating conditions	Min.	Typ.	Max.	Unit		
Max Input Current	Input voltage 43Vdc, output 400W	--	--	12	A		
No Load Input Current	Rated input voltage	--	--	20	mA		
Input Inrush Voltage (1sec. max.)	The unit could be permanently damaged by the input over this voltage	-0.7	--	185	VDC		
Start-up Voltage		--	--	43			
Input Under Voltage Protection	With No-load (the over current protection will work in advance at full load)	--	--	42			
Over Voltage Protection	Test with half load	175	--	200			
ON/OFF Control (CNT)	Positive logic: CNT no connection or connected to 3.5-15Vdc to turn ON, connected to 0-1.2Vdc to turn OFF the converter.					Reference voltage -Vin	
	Negative logic: CNT no connection or connected to 3.5-15Vdc to turn OFF, connected to 0-1.2Vdc to turn ON the converter.						

Output Specifications

Item	Operating conditions	Min.	Typ.	Max.	Unit
Output Voltage Accuracy	Nominal input voltage, 0%-100% load	--	±0.5	±1.0	%
Line Regulation	Full load, input voltage from low to high	--	±0.1	±0.2	
Load Regulation	Nominal input voltage, 10%-100% load	--	±0.1	±0.2	
Transient Recovery Time	25% load step change (step rate 1A/50uS)	--	200	250	uS
Transient Response Deviation		-5	--	+5	%
Temperature Drift Coefficient	Full load	-0.02	--	+0.02	%/°C
Ripple & Noise	20M bandwidth, with external capacitor >470uF	--	200	280	mVp-p
Output Voltage TRIM		-20	--	+10	%
Output Voltage Distal-end Compensation (Sense)		--	--	105	%
Over Temperature Protection	Maximum temperature of the metal base	105	115	125	°C
Over Voltage Protection		125	--	140	%
Over Current Protection		23	--	28	A
Short Circuit Protection		Hiccup, continuous, self-recovery			

General Specifications

Item	Operating conditions		Min.	Typ.	Max.	Unit
Isolation Voltage	I/P-O/P	Test 1min, leakage current <3mA	3000	--	--	VAC
	I/P-Case	Test 1min, leakage current <3mA	2100	--	--	VAC
	O/P-Case	Test 1min, leakage current <3mA	500	--	--	VDC
Insulation Resistance	I/P-O/P	@ 500VDC	100	--	--	MΩ
Switching Frequency			--	260	--	KHz
MTBF			150	--	--	K hours

Environmental characteristics

Item	Operating conditions	Min.	Typ.	Max.	Unit
Operating Temperature	Refer to the temperature derating graph	-40	--	+105	°C
Storage Humidity	No condensing	5	--	95	%RH
Storage Temperature		-40	--	+125	°C
Pin Soldering Temperature	1.5mm from the case, soldering time <1.5S	--	--	+350	
Cooling Requirement		EN60068-2-1			
Dry Heat Requirement		EN60068-2-2			
Damp Heat Requirement		EN60068-2-30			
Shock and Vibration		IEC/EN 61373 C1/Body Mounted Class B			

EMC Performances

EMI	CE	EN50121-3-2	150kHz-500kHz 79dBuV	
		EN55016-2-1	500kHz-30MHz 73dBuV	
	RE	EN50121-3-2	30MHz-230MHz 40dBuV/m at 10m	
		EN55016-2-1	230MHz-1GHz 47dBuV/m at 10m	
EMS	ESD	EN50121-3-2	Contact ±6KV/Air ±8KV	perf. Criteria A
	RS	EN50121-3-2	10V/m	perf. Criteria A
	EFT	EN50121-3-2	±2kV 5/50ns 5kHz	perf. Criteria A
	Surge	EN50121-3-2	Line to line ± 1KV (42Ω, 0.5μF)	perf. Criteria A
	CS	EN50121-3-2	0.15MHz-80MHz 10 Vr.m.s	perf. Criteria A

Physical Characteristics

Case Materials	Metal base + plastic case in black, flame class UL94-V0
Heat Sink	Dimension 116.8x61.0x20.0 mm, weight 150g, aluminum, anodized black
Cooling Method	Conduction cooling or forced air cooling with fan
Unit Weight	Standard 250g, with heatsink 402g

Product Characteristics Graphs

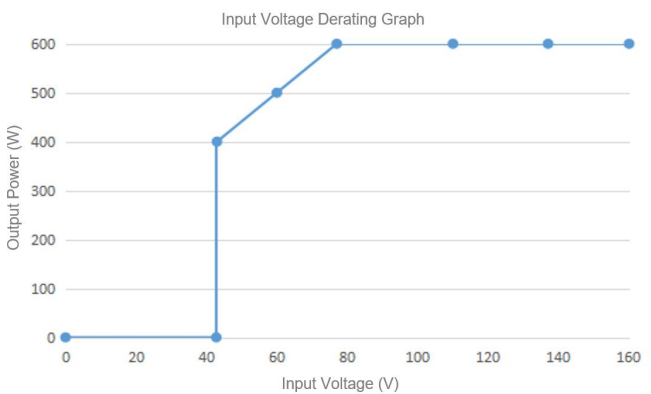
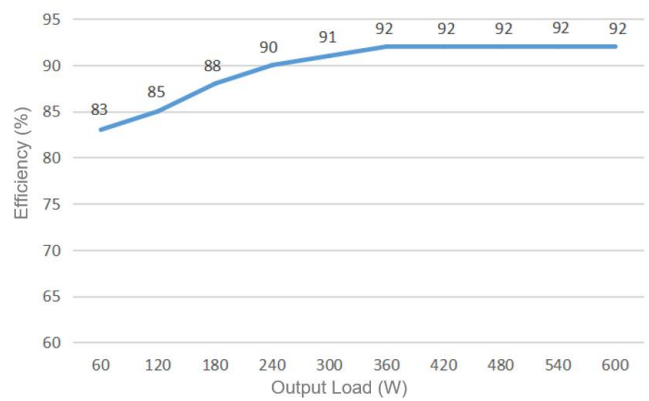
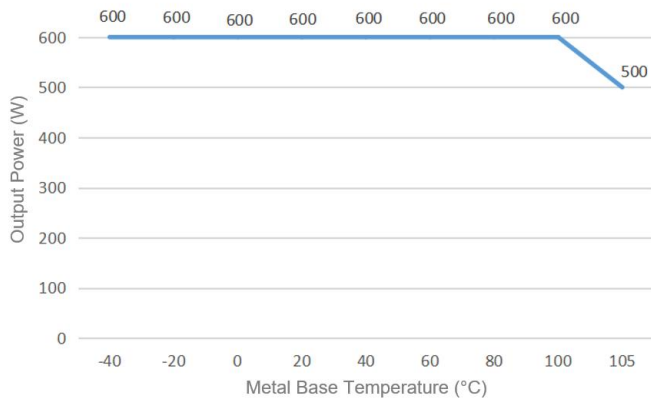

Note:
 1. The output power and the efficiency in the graphs are tested with typical values.
 2. The data in the temperature derating graph is tested at Aipu laboratory test conditions. It is recommended to keep the temperature of the metal base not more than 100 °C when the converter operates at the rated load for the application.

Mechanical Dimensions and Pin-Out Function Description

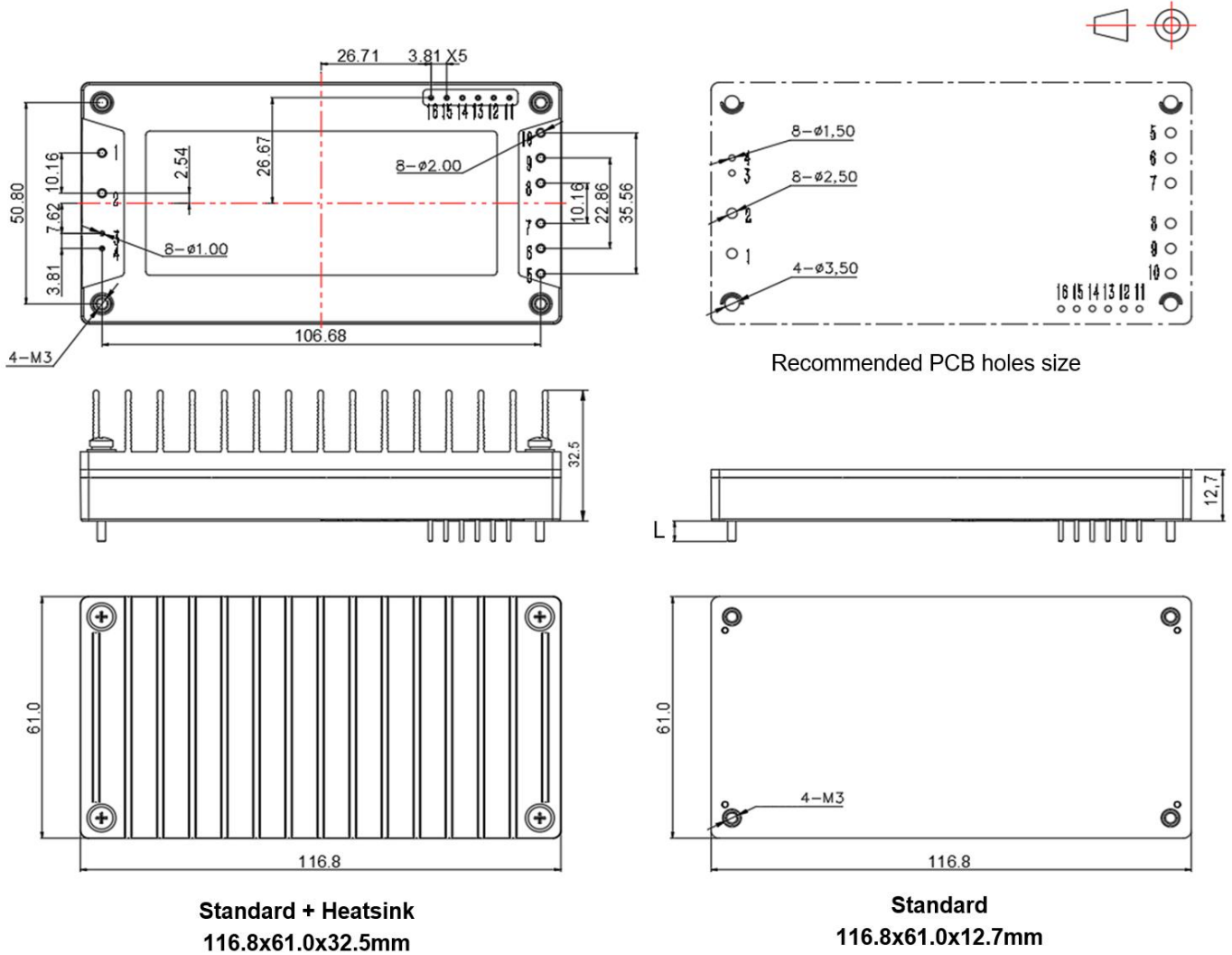

Note
Unit: mm
Pin 1,2,5,6,7,8,9,10 diameter: 2.00
Pin 3,4,11,12,13,14,15,16 diameter: 1.00
Tolerance: X.X ±0.5; X.XX ±0.10
Screwing torque: 0.4 N.m Max

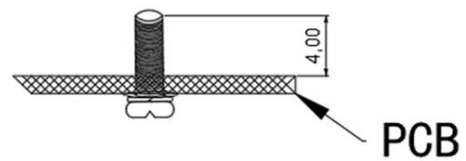

Pin Length L=5.3mm

Pin No.	1	2	3	4	5	6	7	8
Function	Vin-	Vin+	CNT	NC	Vout+	Vout+	Vout+	Vout-
Description	Input V-	Input V+	ON/OFF Control	No Connection	Output V+	Output V+	Output V+	Output V-
Pin No.	9	10	11	12	13	14	15	16
Function	Vout-	Vout-	-Sense	+Sense	TRIM	PC	IOG	AUX
Description	Output V-	Output V-	Output distal end compensation S-	Output distal end compensation S+	Output Voltage Trim	Current share bus	Output Status	Aux-power supply

Note:

- 1.IOG is the output status signal, it is at low impedance while the converter is operating normally, it is at high impedance while the converter is operating under the abnormal condition, the maximum current 10mA.
2. AUX is the auxiliary power supply, the voltage is 12V at normal operation, the maximum overcurrent is 10mA.

Recommended circuits for application

1. Ripple & Noise

All this series of converters will be tested according to the circuit diagram below before shipping.

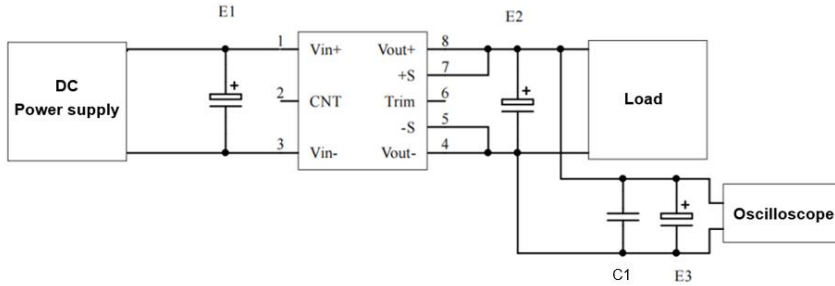

Capacitance Output Volt.	E1 (μF)	E2 (μF)	C1 (μF)	E3 (μF)
3.3VDC	100	1000	1	10
5VDC		680		
12VDC		220		
.....	68	68	1	10
48VDC				
110VDC				

2. Typical application circuit

If this circuit recommended below is not adopted, please use an electrolytic capacitor $\geq 100 \mu\text{F}$ at the input to suppress the possible surge voltage.

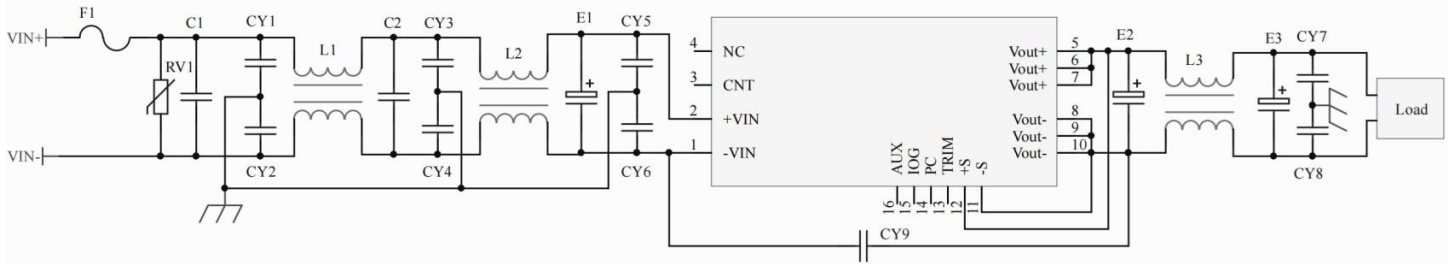

F1	T15A/250V, Time-delay fuse
RV1	14D 200V Varistor
C1, C2	105/250V Polyester Film Capacitor
CY1, CY2, CY3, CY4, CY5, CY6	102/250Vac Y2 capacitor
CY7, CY8	103/2KV Ceramic Capacitor
CY9	471/250Vac Y1 capacitor
E1	220μF/200V Electrolytic Capacitor
E2, E3	470μF/35V Electrolytic Capacitor
L1, L2	>5mH, temperature rise less than 25°@12A
L3	>0.2mH, temperature rise less than 25°@22A

3. ON/OFF control (CNT) application

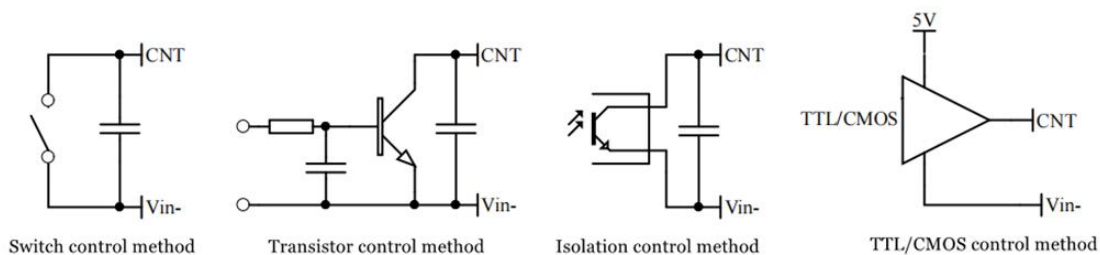

4. Application for Sense

1) With NO distal end compensation

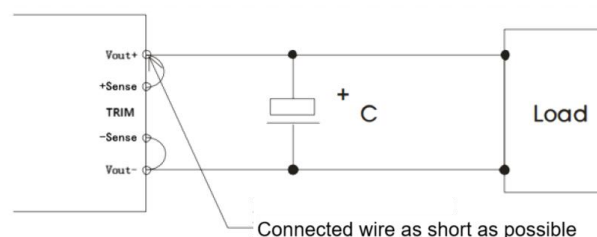

- Notes:
1. Vout+ & Sense+, Vout- & Sense- should be shorted when distal compensation is not needed
 2. The lead wire between Vout+ and Sense+, Vout- and Sense- should be as short as possible, and close to the pins, or else the output may be unstable.

2) With distal end compensation

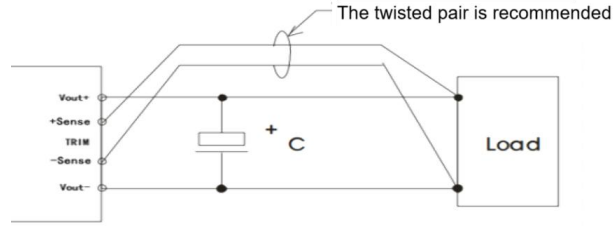

- Notes:
1. The output voltage may be unstable if the compensation cables are too long.
 2. The twisted pair or shielded cables are recommended, the cable length should be as short as possible.
 3. Wide copper path on PCB or thick lead wires between the power supply and the load should be used to achieve the line voltage drop <math><0.3V</math>. The target is to keep output voltage within the specified range.
 4. The leads wire resistance may create the output voltage oscillation or larger ripples. Please verify it before to use.

5. TRIM & TRIM resistance calculation

The calculation of ΔU and Rup & Rdown:

$$R_{up} = 127.5 / \Delta U - 10 \text{ (K}\Omega\text{)}$$

$$R_{down} = 51 * (25.5 - \Delta U) / \Delta U - 10 \text{ (K}\Omega\text{)}$$

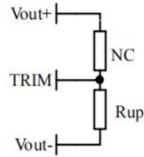

Voltage-up: Add Rup between Trim and Vout-

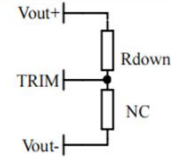

Voltage-down: Add Rdown between Trim and Vout+

6. This series of converters are available to be connected in parallel (recommended circuit diagram below) to increase the output power

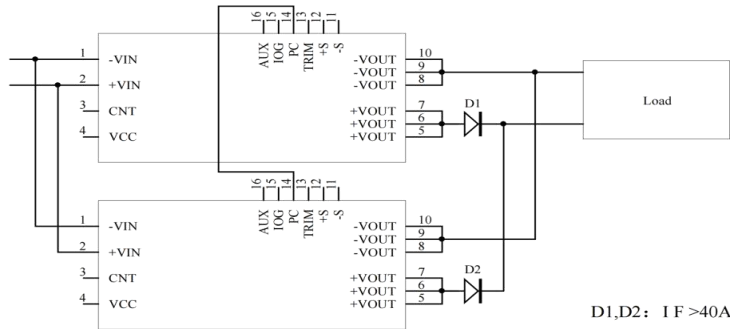

Others

1. The product warranty period is two years. The failed product can be repaired/replaced free of charge if it operates at normal condition. A paid service shall be also provided if the product fails after operating under wrong or unreasonable conditions.
2. Aipupower can provide customization design and filter modules for matching, please contact our technician for details.

Guangzhou Aipu Electron Technology Co., Ltd

Address: Building 4, HEDY Park, No.63, Punan Road, Huangpu Dist, Guangzhou, China.

Tel: 86-20-84206763 Fax: 86-20-84206762 HOTLINE: 400-889-8821

E-mail: sales@aipu-elec.com Website: www.aipupower.com